

# OUTLINE DIMENSIONAL DRAWING

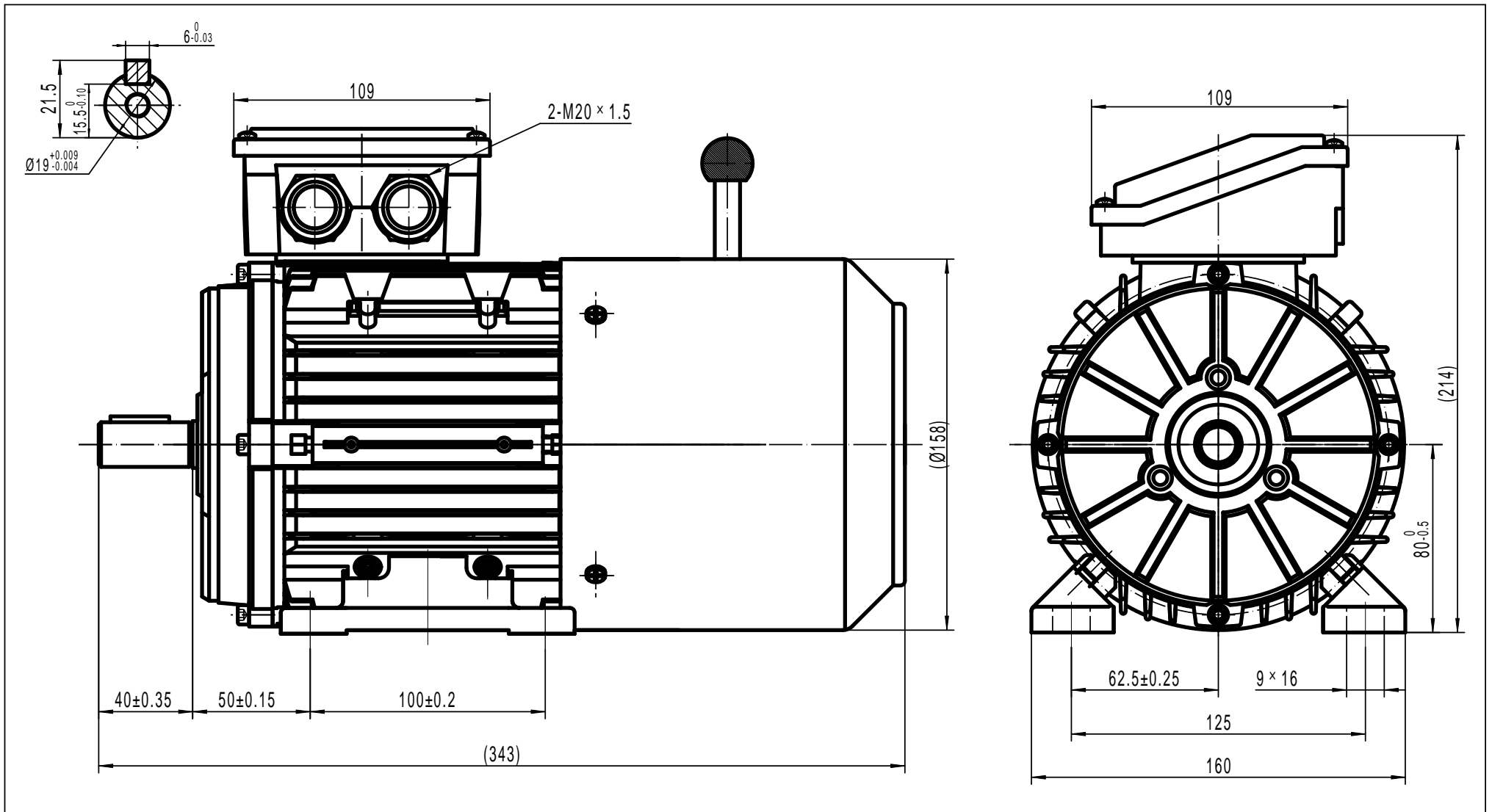

TECHTOP AUSTRALIA PTY LTD	
FRAME	TAIB 80A B3
DATE	DRAWING NO.
2013/10/22	1ST102.050.001-020 A